

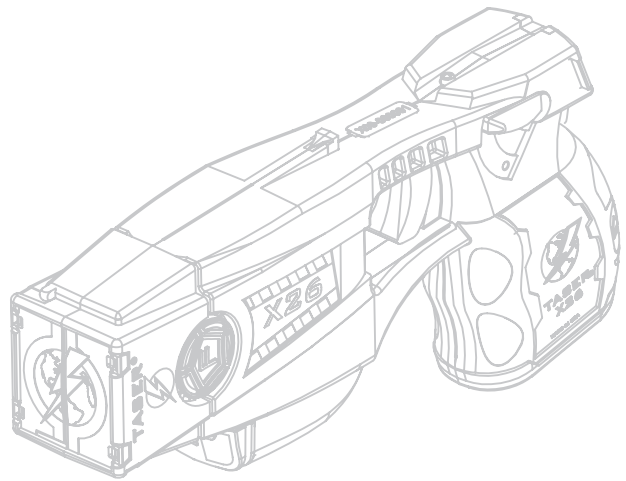

# TASER® X26E™ ECD

## User Manual



### **IMPORTANT SAFETY INSTRUCTIONS.**

Read all warnings and instructions. Save these instructions.

MMU0004 Rev: C

# Contents

## **4 Chapter 1: Warnings**

- 4 Important Safety and Health Information
- 4 Use of Force Policy

## **5 Chapter 2: General Information**

- 5 What is the TASER X26 ECD?
- 5 Neuro Muscular Incapacitation (NMI)
- 6 Common Effects of NMI
- 6 Basic X26 Electrical Theory

## **7 Chapter 3: Features**

- 7 X26 ECD Features
- 7 Safety Switch
- 8 LASER
- 8 High Visibility Sights
- 8 Digital Power Magazine (DPM) or XDPM Battery Pack
- 9 Installing the DPM Battery Pack
- 10 Central Information Display (CID)
- 10 Spark Duration
- 10 DPM Power Level (Energy Cell Indicator)
- 10 X26 Status Data
- 11 Illumination Selector (LASER and LED Flashlights)
- 12 Trigger Switch
- 12 Stainless Steel "Shock" Plates
- 12 Textured Grip Zones





## **13 Chapter 4: Cartridges & ECD Operation**

- 13 Remove the Shipping Cover from the Cartridge
- 13 15, 21, LS21, XP25™, and XP35™ TASER Cartridges
- 14 AFID
- 14 Loading and Unloading the TASER Cartridges
  - 15 Loading
  - 15 Unloading
- 15 Aiming and Probe Placement
- 16 "Silence Is Golden"
- 16 Potential Causes of Reduced or No Effectiveness
- 17 Electrodes

17	Drive-Stun Backup
18	Recommended Drive-Stun Areas for Maximum Effect
19	<b>Chapter 5: Maintenance/Troubleshooting</b>
19	Spark Test
19	Spark Test Instructions
20	What to Do Following TASER ECD Use
20	Considerations for Handling Used Probes
20	Effects On Animals
20	Police/Military K-9 Caution
21	Uploading Software Revisions
21	X26 ECD Maintenance and Care
22	Dropped or Wet X26 ECD
22	TASER Online Troubleshooting Guide
22	Product Returns
23	<b>Chapter 6: Optional Accessories</b>
23	Extended Warranties
23	Data Download Kit
24	EVIDENCE.com™ Lite Services
24	TASER CAM™ Recorder
25	BLACKHAWK! and Blade-Tech Holsters
25	Dual Cartridge Holder
25	Advanced X-RAIL™ Mounting System
26	<b>Chapter 7: Additional Items</b>
26	Additional Information
26	TASER Training Academy
27	Medical Research

## Important Safety and Health Information

Read, understand and follow the product warnings and safety instructions contained in the Product Warnings document included with this electronic control device (ECD). The most current warnings are posted on our website at [www.TASER.com](http://www.TASER.com). Do not attempt to use this ECD until you have completed training with a TASER International Certified Instructor.

 <b>WARNING</b>	
	<b>Complete Training First</b> Significant differences exist between each of the TASER ECD models. Do not use or attempt to use any ECD model unless you have been trained and certified by a Certified TASER Instructor on that particular model.
	<b>Read and Obey</b> Read, study, understand, and follow all instructions, warnings, information, training bulletins and TASER training materials before using the TASER ECD. Failure to comply with the product instructions, warnings, information, training bulletins, and TASER training materials could result in death or serious injury to the user, force recipient, and others.
	<b>Obey Applicable Laws</b> Use the ECD only in accordance with applicable federal, state, and local laws and other regulations or legal requirements. Your agency's guidance must also be followed. Any ECD use must be legally justifiable.
	

TASER® ECDs are weapons designed to incapacitate a person from a safe distance while reducing the likelihood of death or serious injury. Though they have been found to be a safer and more effective alternative when used as directed to other traditional use of force tools and techniques, it is important to remember that the very nature of use of force and physical incapacitation involves a degree of risk that someone will get hurt, or may even be killed due to physical exertion, unforeseen circumstances and individual susceptibilities.

## Use of Force Policy

Each agency is responsible for creating its own use-of-force policy and determining how TASER devices fit into their use-of-force matrix based on legal and community standards. Make sure your agency has a use-of-force policy that addresses TASER ECD use and that this policy is clearly addressed during end-user training.

## What is the TASER X26 ECD?

The X26 is a software upgradable ECD manufactured by TASER International, Inc. ECDs use propelled wires or direct contact to conduct energy to affect the sensory and motor functions of the nervous system.

The X26 ECD uses a replaceable cartridge containing compressed nitrogen to deploy two small probes that are attached to the ECD cartridge by insulated conductive wires. The X26 ECD transmits electrical pulses along the wires and into the body affecting the sensory and motor functions of the peripheral nervous system. The cartridges are available with various wire lengths from 15' to 35' (4.6 meters to 10.7 meters).

A citizen model, the X26C ECD, is also available where legal and has different operating characteristics than the law enforcement model. Sale of cartridges with wire length longer than 15' is limited to law enforcement only.

The X26 ECD has an internal memory that stores the operating software and a record of every deployment. See the **Data Download** section for more details.

The X26 ECD has an estimated useful life of 5 years.

## Neuro Muscular Incapacitation (NMI)

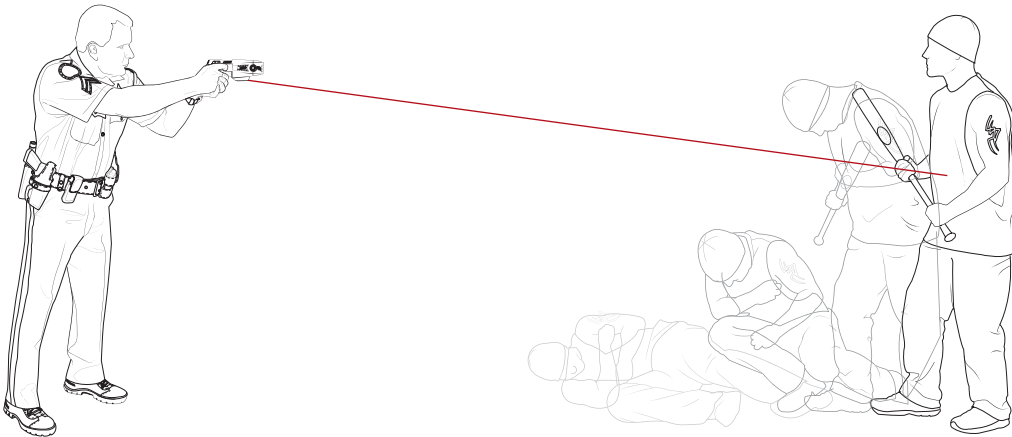

The human nervous system communicates with simple electrical impulses. The command center (brain and spinal cord) processes information and makes decisions. The peripheral nervous system includes the sensory and motor nerves. The sensory nerves carry information from the body to the brain (temperature, touch, etc.). The motor nerves carry commands from the brain to the muscles to control movement and can be involuntary in response to the sensory information. An example would be the involuntary muscle reaction to pull a hand away from a hot object.

TASER technology uses similar electrical impulses to cause stimulation of the sensory and motor nerves. NMI occurs when an ECD is able to cause involuntary stimulation of both the sensory nerves and the motor nerves. It is not dependent on pain and is effective on subjects with a high level of pain tolerance.

Previous generations of stun guns primarily affected the sensory nerves only, resulting in pain compliance. A subject with a very high tolerance to pain (e.g., a drug abuser, or a trained, focused fighter) might be able to fight through the pain of a traditional stun gun.

## Common Effects of NMI



The use of TASER technology causes incapacitation and strong muscle contractions making secondary injuries a possibility. These potential injuries include but are not limited to: cuts, bruises, impact injuries, and abrasions caused by falling, and strain-related injuries from strong muscle contractions such as muscle or tendon tears, or fractures. These injuries are secondary in nature and not directly attributable to the electric output of the ECD, but are possible consequences of the strong muscle contractions the ECD induces to produce incapacitation. Some of the effects may include:

- Falls immediately to the ground and be unable to catch oneself;
- Risk of drowning if ability to move in water or wet environments is restricted;
- Yelling or screaming;
- Involuntary strong muscle contractions;
- Freezing in place with legs locked;
- Dazed feeling for several seconds or minutes;
- Potential vertigo;
- Temporary tingling sensation; or
- Critical stress amnesia (may not remember any pain).

For a full list of warnings, visit [www.TASER.com](http://www.TASER.com).

## Basic X26 Electrical Theory

- Electricity must be able to flow between the probes or the electrodes and will generally follow the path of least resistance.
- The greater the spread between the probes on the target, generally the greater the NMI effectiveness.
- Electricity will generally not pass to others in contact with the subject unless contact is made directly between or on the probes, or the wires are touched.
- Electricity can arc through clothing, and even some bullet-resistant materials.
- Exposure to water will not cause electrocution or increase the power to the subject (the electrical charge is fixed inside the TASER ECD, and will not increase significantly even with environmental changes).
- Medical studies have found that modern pacemakers and implanted cardiac defibrillators withstand external electrical defibrillators many orders of magnitude stronger than the TASER conducted energy pulses.

## X26 ECD Features

Get to know the X26 ECD:

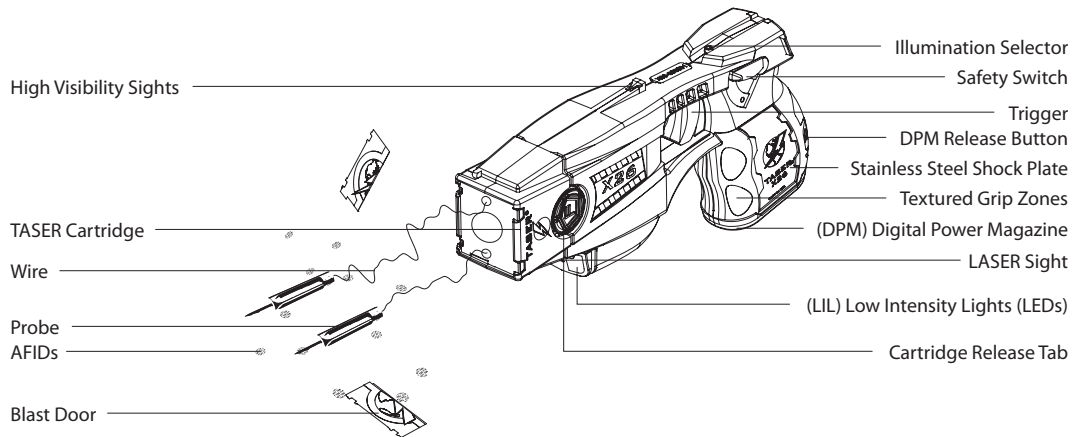

## Safety Switch

Ambidextrous safety switch can be operated from either side of the ECD.

- Safety switch down (SAFE).
- Safety switch up (ARMED) and ready to deploy.
- Do not block the safety switch on one side of the ECD while attempting to move it on the other side. This can break the safety switch and disable the ECD.
- If the X26 safety switch is left in the up (ARMED) position for more than 20 minutes, the system will shut down to preserve battery life. To re-arm the ECD, cycle the safety switch to the down (SAFE) position, then back to the up (ARMED) position.

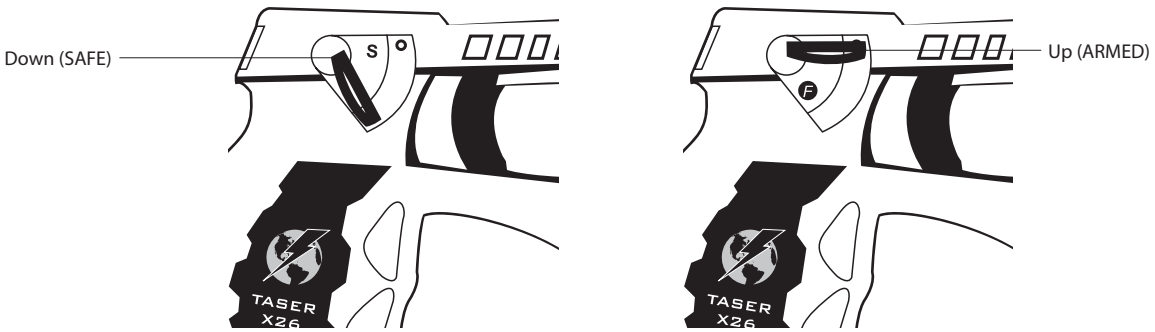

## LASER

The X26 ECD has a LASER sight to aid in aiming. Some agency policies allow the user to use verbal commands and the LASER to “paint the target” to attempt to gain compliance.

## High Visibility Sights

The mechanical sights on the X2 ECD are molded to provide manual aiming of the ECD. The mechanical sights are set to coincide with a top probe’s trajectory at a 15-foot distance.

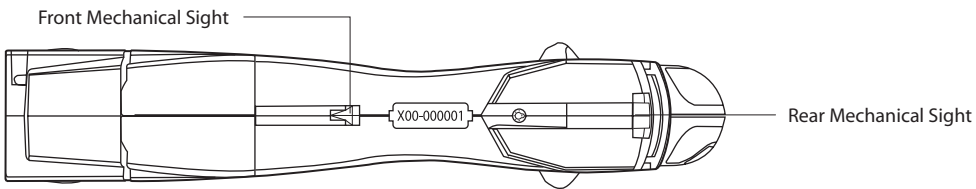

## Digital Power Magazine (DPM) or XDPM Battery Pack

The Digital Power Magazine is much more than just a lithium energy cell power supply system for the X26 ECD. In addition to the lithium energy cells that power the X26 ECD, the DPM also contains an onboard memory chip that maintains a record of the remaining power level in the battery. The DPM memory also contains specific information of energy cell performance and life expectancy for the energy cell pack at various temperatures and for various loads.

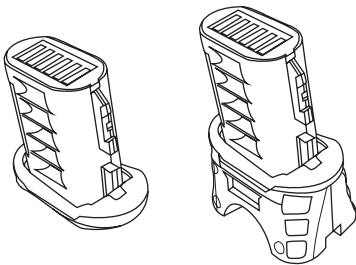

The X26 ECD keeps track of how much the various features of the weapon are affecting the energy cell life and updates the memory in the DPM accordingly. The battery percentage indicated is a calculated value and not a direct reading of the battery voltage. Do not store the DPM anywhere that the gold contacts on the top of the DPM may touch metal objects. If you cause an electrical short between these contacts, it will drain the



lithium energy cells, but the DPM will continue to show 99% power. The power level indicator only registers power consumed by the X26 ECD. If you short-circuit the DPM, it will malfunction and the energy lost during the short-circuit will not be registered or tracked in the DPM. The DPM also contains memory that can update the X26 ECD software.

The X26 ECD must be stored with the DPM/XDPM inserted at all times. If the DPM/XDPM is left out for an extended period of time, software in the X26 ECD may be damaged, resulting in possible failure of the ECD and the date/time may be reset.

The DPM battery has enough power for approximately 195 five-second firings depending on temperature. The DPM battery will use more energy in colder weather than warm weather. The eXtended Digital Power Magazine (XDPM) has all the same features as the DPM, plus a holder for a spare TASER cartridge.

## Installing the DPM Battery Pack

The X26 ECD is shipped with the DPM battery pack pre-installed. To change the DPM:

- 1 Shift the safety switch to the down (SAFE) position.
- 2 Remove the TASER cartridge.
- 3 To unload the DPM, depress the DPM release button and remove the DPM from the handle of the ECD.
- 4 Wait approximately 5 seconds, then install the new DPM. Ensure that the DPM is fully inserted into the X26 ECD. Apply sufficient force to compress the foam gasket and allow the DPM battery pack to seat fully. Verify that the DPM release button pops out from the recessed position with an audible click. Failure to do so could result in a damaged X26 ECD or a loss of power during a deployment. When the DPM is installed, the X26 ECD will cycle through the boot-up sequence (see *X26 Status Data*).

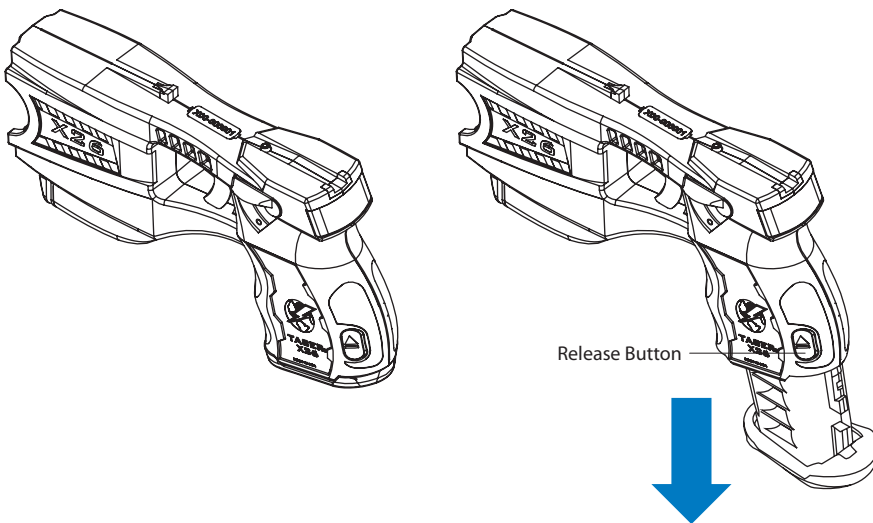

## Central Information Display (CID)

The CID is a two-digit display on the back of the X26 ECD that provides the following information:

### Spark Duration

When the X26 ECD is discharged, it delivers an approximately 5-second Shaped Pulse energy burst. The CID displays a countdown from 5 to 0 (in the following sequence for software versions 20 or higher: 05, 04, 03, 02, 1111, 00) indicating how many seconds remain in the current burst. If the trigger is held down longer than 5 seconds, the CID will continue to display a "0" for the remainder of the energy burst. The burst can be stopped at any time during the automatic 5-second cycle by shifting the safety switch to the down (SAFE) position.

### DPM Power Level (Energy Cell Indicator)



The estimated remaining battery capacity is displayed as a percentage.



### X26 Status Data

When a DPM is inserted in the X26 ECD, the ECD will enter a "boot-up" sequence and cycle through the following information:

#### Example:



00

00

00

07 Current year (2007)

08 Current month (August)

- 09 Current date (9th)
- 12 Current hour (GMT)
- 22 Current minutes
- 27 Internal temperature of the X26 (27 °C)
- 18 X26 software version (18)

---

## Illumination Selector (LASER and LED Flashlights)

The operator can select four modes of illumination when using the X26 ECD.



- LF** LASER and Flashlight both illuminate
- LO** LASER only will illuminate
- OF** Only Flashlight will illuminate
- OO** Neither the LASER nor the Flashlight will illuminate and the CID display is dimmed

To change the illumination setting:

- 1 Place the safety switch in the down (SAFE) position, remove the TASER cartridge, and aim the X26 ECD in a safe direction (such as toward the ground). NOTE: The illumination selector is disabled if the safety switch is in the up (ARMED) position.
- 2 Press and hold the Illumination Selector for approximately 1 second until the CID display illuminates.
- 3 Press and release the Illumination Selector to toggle through the four available settings until the setting you desire is designated on the CID. Stop when the setting you desire is displayed.
- 4 The selected mode displays for 5 seconds, and will be the default mode the next time the safety switch is moved to the up (ARMED) position.

NOTE: Using pens or paper clips to press the Illumination Selector may damage it. Only use your finger to press the Illumination Selector.

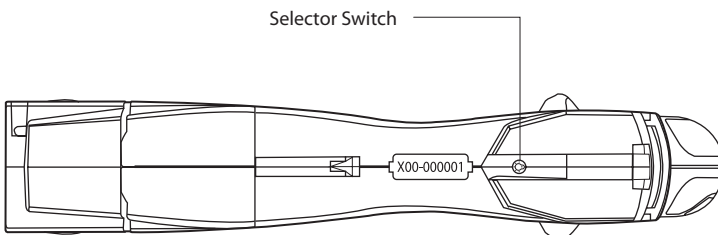

## Trigger Switch

Unlike a firearm trigger, the X26 ECD trigger is a momentary electrical switch. The switch is operational only when the safety switch is in the up (ARMED) position. Pulling and releasing the trigger switch will result in an approximately 5-second discharge unless the safety switch is shifted to the down (SAFE) position during the discharge. Pulling and holding the trigger switch for more than 5 seconds will result in a continuous discharge until the trigger switch is released, or the battery is depleted—whichever happens first.



**In the event of an accidental discharge, immediately move the safety switch to the down (SAFE) position to stop the discharge cycle.**

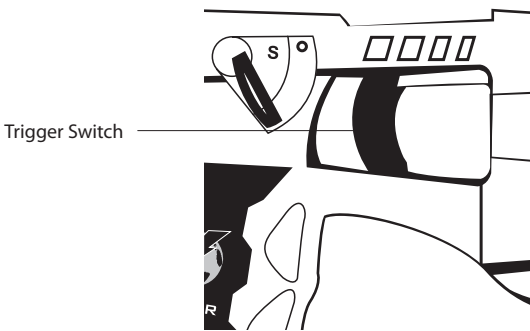

## Stainless Steel “Shock” Plates

The sides of the DPM compartment have stainless steel “shock” plates for added strength. Shock plates are available in silver and black colors.

## Textured Grip Zones

The handle of the X26 ECD is optimized for maximum grip in minimal size. Textured grip zones strategically located in the areas of maximum hand-to-weapon friction offer superior grip and weapon control under stress.



## Removing the Shipping Cover from the Cartridge

Cartridges are shipped with a shipping cover in place. Remove these covers before attempting to load a cartridge into the X26 ECD. A cartridge cannot be loaded into the ECD with the cover in place. Once the cartridge cover is removed, it can be disposed of.



- 1 Before removing the covers, make sure the front of the cartridge does not point at any body part or at anyone.
- 2 Place the cartridge with the cover face down (blast door down) onto a stable/solid surface, i.e., a table.
- 3 Place your index and middle fingers onto the sides of the cartridge where the wedges/electrodes are located, and place your thumbs onto the locking portions of the cover.
- 4 Push in with your fingers and pull outward with your thumbs and the cartridge will pop upward, releasing it from the cover.

NOTE: The cartridge may pop upward quickly when the pressure is released from the locking portions of the cover.

## 15, 21, LS21, XP25™, and XP35™ TASER Cartridges



**The XP35 TASER cartridge is not reversible. It has raised orange arrows printed on the side of the cartridge that is inserted towards the top of the ECD.**

**Never attempt to open or modify a TASER cartridge. Tampering with a live TASER cartridge could cause it to fire or malfunction (which may result in serious injury).**

**Handle all TASER cartridges with care. Probes may deploy unexpectedly if exposed to physical shock, or static electricity.**

The firing sequence for all TASER cartridges is designed to be initiated by an electrostatic discharge delivered by the TASER ECD. This is an important design and functional element for the TASER ECD and cartridge. However, an electrostatic discharge can come from many sources. When an electrostatic discharge, regardless of the source, contacts the front of a TASER cartridge, it is possible for the cartridge to discharge (and even to discharge when not inserted into the ECD).

TASER cartridges should be kept away from conditions known to create an electrostatic discharge, such as rubbing cloth (e.g., jacket liner) across a cartridge in an environment known to create static shocks.

Occasionally, blast doors will be knocked off the front of a cartridge. Because those cartridges cannot be relied upon to consistently discharge, TASER recommends removing those cartridges from service. TASER operators should not attempt to fire a cartridge with no blast doors on it unless they are facing an immediate threat and do not have the time or option to reload. Attempting to deploy a cartridge with no blast doors could result in a charge being created and held in the wires. Any conductive material that comes into contact with the front of the cartridge, even after the cycle has ended, could draw the charge to the ignition pin and deploy the probes.

TASER offers a Blast Door Repair Kit that can be used to safely replace blast doors that come off. Cartridges with replaced blast doors should only be used for training and should not be deployed to the field. Go to [www.TASER.com](http://www.TASER.com) for more information on the Blast Door Repair Kit.

## AFID

Every time a TASER cartridge is deployed, at least 20–30 small confetti-like Anti-Felon Identification (AFID) tags are ejected. Cartridges can be assigned to individual users, as each is serialized. Each AFID tag is printed with the corresponding serial number of the cartridge deployed, allowing determination of which user deployed the cartridge.

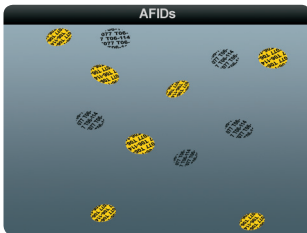

## Loading and Unloading the TASER Cartridges



**Never place your hands, fingers or other body part in front of the cartridge when loading or unloading the cartridge. Serious injury could result. When loading and unloading, always hold the cartridge on the sides or top.**

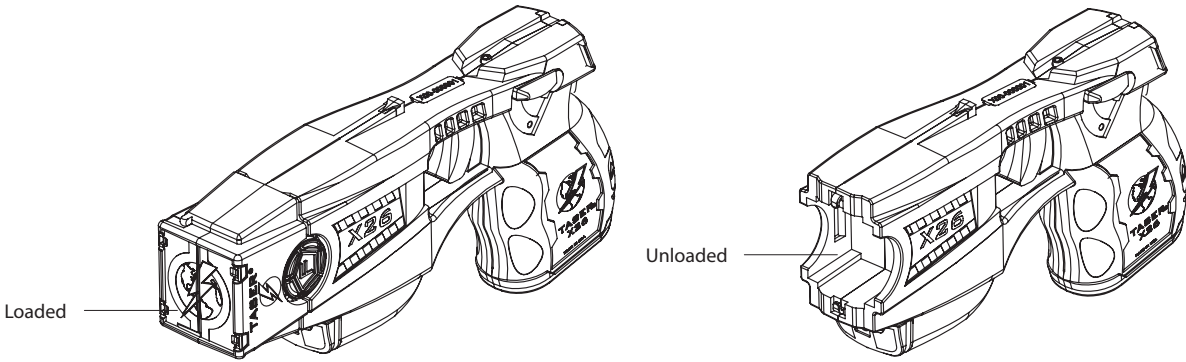

## Loading and Unloading the TASER Cartridges

### Loading

- 1 Point the ECD in a safe direction.
- 2 Ensure that the safety switch is in the down (SAFE) position.
- 3 Keeping your hand away from the blast doors, place the cartridge (with the cartridge cover removed) into the front of the ECD until an audible click is heard.
- 4 Verify that the cartridge is secure by pulling on the sides of the cartridge.

## Loading and Unloading the TASER Cartridges

### Unloading

- 1 Point the ECD in a safe direction.
- 2 Ensure that the safety switch is in the down (SAFE) position.
- 3 Keeping your hand away from the blast doors, depress the tabs on the sides of the cartridge and remove.

The 15-, 21-, and 25-foot (4.6 m, 6.4 m, and 7.6 m, respectively) TASER cartridges are specifically designed so there is no “up” or “down” position – enabling you to quickly reload one in a stressful situation without worrying about putting it in upside down. (The 35-foot [10.7 m] cartridges must be loaded a specific way. See the 35-foot TASER cartridge specifications for more information).

## Aiming and Probe Placement

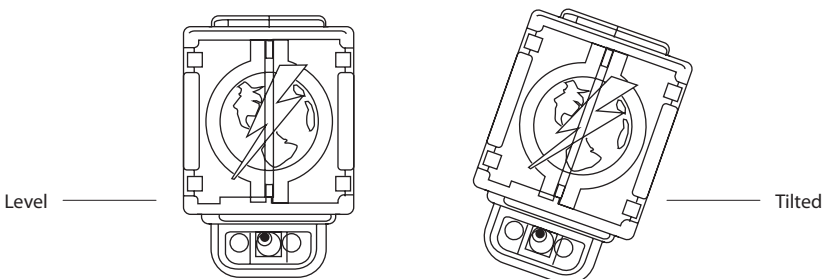

For most deployments, hold the ECD level. Do not tilt the ECD unless it is necessary to do so to align the ECD with the target.

All TASER ECD deployments should be in accordance with department training, policies, and procedures.

Normally, aim the LASER at the preferred target areas of the body, which are the lower torso (when the subject is facing you), legs, and the subject's back.

## **WARNING**

**Avoid head, face, throat, or groin exposure unless officer safety or the situation dictates otherwise.**

The top probe impacts the target near the LASER beam; however, the probe impact distance from the LASER will vary depending on the distance between the ECD and the target, type of cartridge, etc.

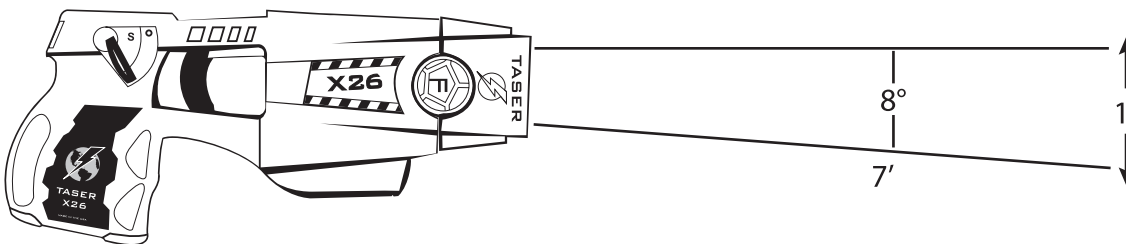

The bottom probe impacts at an 8-degree angle from the top probe (except with the XP35 cartridge). This results in a spread of approximately 1' (0.3 m) for every 7' (2.1 m) of distance from the ECD. Greater probe spread increases effectiveness.

## “Silence Is Golden”

The TASER ECD's electrical current is relatively quiet when both probes make direct contact with a human or an animal. In contrast, some practice conductive targets are loud because the energy is arcing in the air.

If electrical current is loud during field deployment and the subject is not reacting as expected, the electrical circuit may not be completed or the current may be shorting out and may not be effective. Deploy a second cartridge or consider other options.

## Potential Causes of Reduced or No Effectiveness

- **Loose or Thick Clothing.** If the probes lodge in clothing and are too far away from the subject, ECD effectiveness is reduced or prevented.
- **Miss or Single Probe Hit.** The current must pass between the probes. If one probe misses, a second cartridge may be deployed if practical and legally justifiable. Using the X26 ECD in the drive-stun mode as described below may also complete the circuit between the single probe and the ECD electrode.
- **Low Nerve or Muscle Mass.** If the probes impact in an area where there is very little muscle mass (e.g., the side of the rib cage), the effectiveness can be significantly diminished.
- **Limited Probe Spread.** Small probe spreads (including drive-stun) result in little or no effect from NMI and become primarily a pain compliance option.
- **Wires Break.** If a wire breaks (e.g., during a struggle), the current will not flow to the probes. Drive-stun is still available.



## WARNING

**Do not become dependent on the TASER ECD. No ECD is 100% effective in every situation. Do not deploy the TASER ECD without following department policies and procedures.**

### Electrodes

The front of the X26 ECD has two metal electrodes. These electrodes direct the charge to the electrodes on the cartridge to initiate deployment of the probes. In addition, the electrodes provide the ability to use the X26 ECD in a “drive-stun” mode as a traditional stun-gun type ECD.

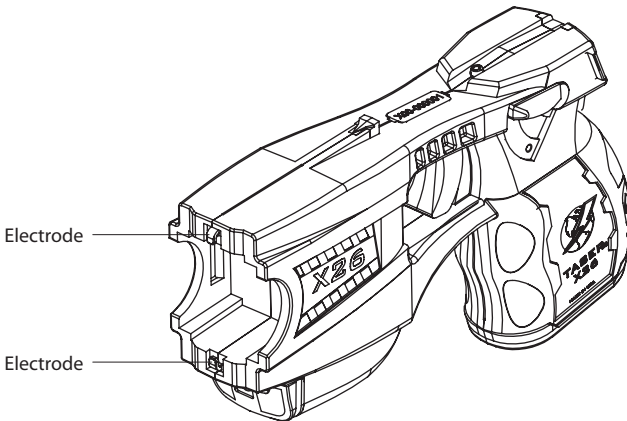

### Drive-Stun Backup

Drive-stun capability is available with or without a TASER cartridge installed. To apply a drive-stun, place the safety in the up (ARMED) position and pull the trigger. The drive-stun mode generally will not cause NMI and becomes primarily a pain compliance option. Probe deployment is usually considered more desirable, even at close range. Some of the advantages of probe deployment include:

- Drive-stun is only effective while the ECD is in contact with the subject or the subject’s clothing. As soon as the ECD is moved away, the energy being delivered to the subject stops. Deploying the probes allows the user to separate from the subject while maintaining control.
- Due to automatic reflex actions, most subjects will struggle to separate from the TASER ECD when it is used in the drive-stun mode. Each time the ECD comes back in contact with the individual, another set of marks may be visible. Using the probes allows for one point of discharge.
- If the probes are deployed, even at very close range, the user may be able to use drive-stun to another portion of the body that is farther away from the probes, thereby increasing the chance of NMI.

If the drive-stun is not effective, evaluate the location of the drive-stun, consider an additional cycle to a different pressure point, or consider alternative force options.

When using the drive-stun, push (drive) the front of the X26 ECD firmly against the body of the subject. Simply “touching” the X26 ECD against the subject is not sufficient. The subject is likely to recoil and try to get away from the electrodes. It is necessary to aggressively drive the front of the X26 ECD into the subject for maximum effect.

## Drive-Stun Backup

### Recommended Drive-Stun Areas for Maximum Effect

Pursuant to your agency's policies and guidance, when operator safety is at risk, drive the X26 ECD into the following areas for maximum effectiveness.

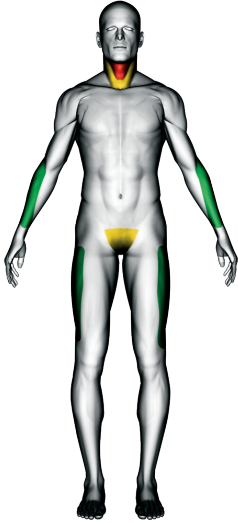

- Carotid (sides of neck) (see warning below).
- Radial (forearm).
- Pelvic triangle (see warning below).
- Common peroneal (Outside of thigh).
- Tibialis (calf muscle).



**Use care when applying a drive-stun to the neck or groin. These areas are sensitive to mechanical injury (such as crushing to the trachea or testicles if applied forcefully). However, these areas have proven highly effective targets. These areas should only be targeted when users are defending themselves from violent attacks. Refer to your department's policy regarding drive-stuns in these and other sensitive areas.**

## Spark Test

TASER recommends conducting a spark test every 24 hours or prior to the start of your shift for your individually issued X26 ECD.

It is not necessary to use an extended duration. As long you see a visible spark between the electrodes (one second), the X26 ECD is functional.

The reasons for the spark test include:

- To verify the TASER ECD is working.
- To verify that the DPM battery pack is adequately charged.
- To energize the components in the high voltage section of the X26 ECD on a regular basis.

## Spark Test Instructions

- 1 Point the ECD in a safe direction.
- 2 Ensure that the safety switch is in the down (SAFE) position.
- 3 Ensure that the TASER cartridge is removed. A spark test should never be conducted with a TASER cartridge in the ECD.
- 4 Ensure that no part of your body, including your fingers, is in front of the X26 ECD.
- 5 Shift the safety switch to the up (ARMED) position.
- 6 Pull the trigger and visually confirm sparking across the electrodes.



**View the arc from the top or side of the ECD. Do not point the ECD at your face.**

- 7 Shift the safety switch to the down (SAFE) position.

## What to Do Following TASER ECD Use

### Considerations for Handling Used Probes



#### **Biohazard**

Each agency will establish its own procedure for probe removal and collection. Treat probes that have penetrated the body as contaminated needles (biohazard).

If the probes must be removed from the subject, follow all department policies and procedures for handling biohazards. Below are suggested methods for probe removal:

- Grab the probe firmly and quickly pull it straight out. Do not twist the probe as the barbed tip may cause additional injury.
- Carefully place used probes sharp-tip first into either a sharps container or into the cartridge side wire pocket container, secure in place, and place in a secure location where no one will accidentally touch the probes.
- Once the subject is restrained, evaluate the need for medical attention as you would with any other use-of-force incident.\*
- Take photos of any injuries, place the photos into evidence.\*
- Collect the expended cartridge, probes, and AFIDs and place them into evidence.\*

\* As directed by department policy. The TASER training materials provide additional information on forensic evidence collection procedures.

### **Effects on Animals**

The X26 ECDs are an effective option for dealing with aggressive animals and have generally been successful in most deployments. If deployed on a domestic animal, consider having animal control available to restrain the animal.

NOTE: The aggressive animals are usually incapacitated/stunned momentarily, but recover quickly. The vast majority of the animals quickly left the scene and broke the wires.

### **Police/Military K-9 Caution**

ECD operators and K-9 officers must work closely together to develop policies and procedures for deploying the ECD when a K-9 is present. If a K-9 bites a probe or bites the suspect between the probes, the K-9 could receive a shock. This could have a negative impact on the future duty use of the K-9.

## Uploading Software Revisions

The X26 internal software provides functionality for all aspects of the ECD. The software can be upgraded to the most recent version through a DPM or XDPM battery pack, or TASER CAM™ recorder. Each DPM battery pack contains a copy of the weapon software. When the DPM battery pack is first inserted in the X26 ECD, the logic will compare the software version in the weapon with the software version in the DPM. If the DPM battery pack contains a newer version, the software will automatically be uploaded into the X26 ECD. During the uploading, the CID will display a “P.” When uploading is complete, the CID will display the boot-up sequence. The last number in the sequence is the new software version. The programming process takes approximately 10 seconds.



**DO NOT remove the DPM battery pack or move the safety switch to the up (ARMED) position during the software programming cycle. This will result in corruption of the data and the X26 ECD will have to be returned to the factory for reprogramming.**

You can always install a previous version DPM in the ECD. The software will not program the X26 ECD to an older version and the weapon will remain at the higher of the software versions in the ECD or in the DPM.

## X26 ECD Maintenance and Care

Each agency should establish a maintenance and handling program.



**The X26 product is a sensitive electronic piece of equipment, and should be handled with care. Avoid dropping an X26 ECD. Do not use an X26 ECD that has a cracked handle.**

- Check the battery pack regularly. Replace it when the battery percentage reaches 20%.
- NOTE: The X26 ECD must be stored with the battery pack inserted at all times. Failure to do so may result in loss of time and date settings, software corruption, and/or ECD failure. If the battery pack is left out for an extended period of time, the software in the ECD may be damaged and the date/time may be reset. Refer to the online troubleshooting guide at [www.TASER.com](http://www.TASER.com).
- Check expiration of TASER cartridges (5-year expiration date is listed on the base of the cartridge). Do not use an expired TASER cartridge in the field. Expired cartridges should only be used for training.
- Occasionally wipe out the cartridge firing bay with a dry cloth. Multiple cartridge firings create carbon build-up (particularly after training courses).
- Secure in protective holster when not in use.
- When an X26 ECD is returned to TASER International for repair, the download data will be lost. Download the data before returning the unit.
- Avoid exposing the X26 ECD to excessive moisture, or water.
- See the troubleshooting guide at [www.TASER.com](http://www.TASER.com) for detailed instructions.

## Dropped or Wet X26 ECD

If your X26 ECD is dropped or gets wet, follow these instructions:

- 1 Point the ECD in a safe direction and away from your body.
- 2 Shift the safety switch to the down (SAFE) position.
- 3 Safely remove the cartridge.
- 4 Remove the battery pack.



**Dry the X26 thoroughly (at least 24 hours). Do not use an external heat source such as a microwave oven or hair dryer to dry the X26 ECD.**

- 5 Reinstall the battery pack.
- 6 Shift the safety switch to the up (ARMED) position.
  - If the X26 ECD discharges without pulling the trigger, remove the battery pack and return the X26 ECD to TASER International immediately.
- 7 Spark test three full 5-second cycles.
  - If the X26 ECD does not function properly, return it to TASER International.
  - If the spark test is normal, return the X26 ECD to service.
- 8 Shift the safety switch to the down (SAFE) position.

## TASER Online Troubleshooting Guide

A troubleshooting guide is available by visiting the TASER website at [www.TASER.com](http://www.TASER.com). If you need product support on accessories or have any other questions, please contact customer service at:

U.S.: 1.800.978.2737 or 1.480.905.2000

International: +1.800.978.2737 or +1.480.905.2000

## Product Returns

To return a TASER product for service, first follow the procedures at [www.TASER.com](http://www.TASER.com).



**Perform a dataport download from the X26 ECD before returning it for RMA.**

**If the TASER ECD has been exposed to bodily fluids or other bio-hazards, please contact the customer service department at +1.800.978.2737 or +1.480.905.2000 for specific instructions BEFORE returning the ECD.**

## Extended Warranties

See [www.TASER.com](http://www.TASER.com) for information about extended warranties.

## Data Download Kit

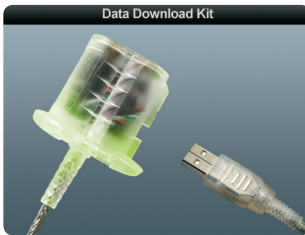

Optional download kits are available to permit departments to access the encrypted deployment information in the X26 memory.

The X26 ECD has a highly advanced download function that can help protect a user from claims of excessive use of force by providing documentation of the time and date for each firing. The dataport also provides law enforcement with a powerful management tool to track usage patterns and prevent misuse.

The data download record includes the following information for the last 2,000+ discharges:

- Date, time, and duration of each discharge in both GMT and local time.
- Temperature and DPM battery percentage remaining at each discharge.
- Record of any time changes made to the ECD memory.
- ECD serial number and current software version.

The X26 download interface uses a USB adapter to connect to any Windows® XP, Windows Vista®, or Windows 7 (32-bit) computer. The simplicity of USB makes using the dataport an easy, fast process. The cable connects to the X26 ECD through the DPM compartment.

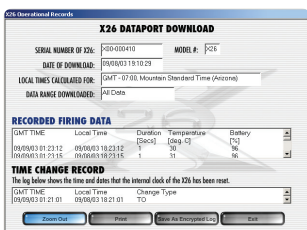

The X26 ECD is programmed to Greenwich Mean Time (GMT) at the factory. The conversion to local time, including adjustments to daylight savings time, are all computed in the PC-based software. There is no need to program the weapon to local time or to reprogram the weapon to daylight savings time.

**Secure “.x26” data files:** The data downloads are saved in encrypted .x26 data files that are more secure than a Word document. This preserves the integrity of X26 dataport download reports for court admissibility.

## EVIDENCE.com™ Lite Services

You also can download your X26 ECD using EVIDENCE.com Lite. EVIDENCE.com Lite is a free version of EVIDENCE.com services for downloading the X26 ECD and the TASER CAM recorder.

Go to [www.evidence.com](http://www.evidence.com) for information on obtaining the free EVIDENCE Sync™ download software, which is required to download the devices.

## TASER CAM™ Recorder

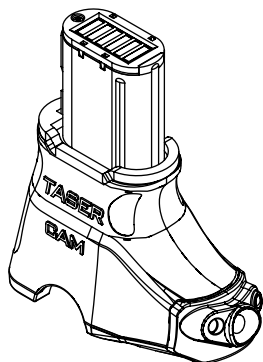

The TASER CAM recorder is an audio-video recording device integrated into a rechargeable X26 power supply that replaces the standard DPM battery pack and is compatible with all X26 ECDs. The TASER CAM recorder is activated any time the safety switch is in the up (ARMED) position. This allows officers to capture vital information prior to, during, and after the deployment or potential deployment of the X26 ECD.

The TASER CAM battery is fully rechargeable and is capable of approximately 100 5-second discharges. Charging is accomplished through a 110-volt wall adapter or through the USB cable.



The TASER CAM recorder uses an infrared light source for low light and no light capability. The TASER CAM records approximately 1.5 hours of video before recording over previous files (continuous loop system).

Video and audio is downloaded via a USB cable and download software or the EVIDENCE.com website. Standard X26 firing data may also be downloaded using the same system.



## BLACKHAWK! and Blade-Tech Holsters

The X26 ECD ships with either BLACKHAWK!® SERPA™ or a Blade-Tech holster. Both holsters fit on a duty belt. A variety of accessories are available for both holsters including cartridge carriers and quick-release Blade-Tech Tek-Lok™ belt clips.

The BLACKHAWK! and Blade-Tech holsters are available in both right and left-hand configurations.



## Dual Cartridge Holder

The Dual Cartridge Holder attaches to the top of a Blade-Tech holster (screws and hex key included), allowing you to carry two spare cartridges conveniently on your belt. The Dual Cartridge Holder can also be attached to a Tek-Lok belt mount by itself (or even two Dual Cartridge Holders can be attached to a Tek-Lok, holding four cartridges on your belt).

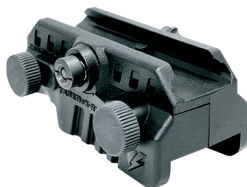

## Advanced X-Rail™ Mounting System

The X-Rail mounting system allows the attachment of the X26 ECD to military and law enforcement rifles through a Picatinny Rail, an accessory that allows the attachment of items such as lights, sighting systems, and now the X26E ECD. The X-Rail mount was originally developed by TASER to support the U.S. military efforts in Iraq and Afghanistan. The integration of the X-Rail mount and X26 ECD into a weapon platform allows officers to make split second transitioning from the firearm to the TASER option.

## Additional Information

New TASER brand products are under development. Visit our website at [www.TASER.com](http://www.TASER.com) for the latest information.

Material Safety Data Sheets (MSDS) for lithium batteries are available by contacting TASER International.

## TASER Training Academy

The TASER Training Academy is designed to provide training on the use of TASER-brand ECDs. Training is geared toward the special needs of law enforcement officers, correctional officers, medical personnel, the military, professional security, and private citizens. ECD functions, medical issues, device maintenance, and personal safety are just a few of the topics covered in the offered courses.

Located at TASER International's headquarters in Scottsdale, Arizona, the TASER Training Academy features a state-of-the-art classroom facility complete with 48 work stations equipped with power and internet access, safety mats, and the Ti Training interactive training simulator.

We "fight like we train." It is for this reason that we emphasize hands-on, interactive and scenario-based training. Most of our courses involve some degree of physical activity and participation. We make every effort to simulate real-life stress and circumstances, to provide realistic training to better prepare the student for success in the field. Through the use of our Ti Training interactive force simulator and TASER Simulation Training Suits, we promote sound use of force judgment, tactics and follow up procedures.

Our cadre of instructors consists of active and former law enforcement officers and military trainers. Many are internationally recognized experts in use of force at all levels with extensive training backgrounds.

All of our instructors are committed to providing the best training possible and to forming lasting relationships to support our students long after they leave the Academy.

For more information visit our website [www.TASER.com](http://www.TASER.com) or give us a call at +1.800.978.2737 option 7 or +1.480.905.2000.

Courses:

- TASER Electronic Control Device User Course
- TASER Electronic Control Device Instructor Course
- TASER Online User Course
- TASER Master Instructor Course

- TASER Wildlife ECD Course
- TASER Technician Course
- TASER Evidence Collection and Analysis Course
- TASER Use of Force, Risk Management and Legal Strategies Seminar

## Medical Research

TASER ECDs are among the most extensively studied ECDs. More than 300 medical and field studies have been published. For more information go to [www.TASER.com](http://www.TASER.com).

U.S.: 1.800.978.2737 or 1.480.905.2000

International: +1.800.978.2737 or +1.480.905.2000

[www.TASER.com](http://www.TASER.com)





BLACKHAWK® is a registered trademark of BLACKHAWK! Products Group.

SERPA™ is a trademark of BLACKHAWK! Products Group.

Tek-Lok™ is a trademark of Blade-Tech Industries.

Windows® is a registered trademark of Microsoft Corporation in the U.S. and other countries.

Windows Vista is either a trademark or registered trademark of Microsoft Corporation in the U.S. and other countries.

EVIDENCE.com™, EVIDENCE.Sync™, Shaped Pulse™, TASER CAM™, X26™, XP25™, XP35™, X-Rail, 'Protect Life',  and  are trademarks of TASER International, Inc., and TASER® is a registered trademark of TASER International, Inc., registered in the U.S. All rights reserved. © 2011 TASER International, Inc.